

## Warranty



To receive after-Sale service, have the following ready when you contact our branches

1. Name of the product
2. Model number of the product
3. The area of problem
4. Phone number and address at which you can be contacted.

## Warranty Card

PRODUCT	
MODEL	
DATE PURCHASED	
WARRANTY PERIOD	
AGENCY ADDRESS	

### ■ KOCOM Warranties the original purchaser of this product as follows.

- 1) This product is produced under strict quality control and inspection procedures.
- 2) If this product breaks down during proper use as a result of product defect, KOCOM will repair it within one year from date of purchase free of charge.
- 3) The following cases will be subject to charge, even during warranty period:
  - a. Breakdown during transport, or through careless treatment, by consumer.
  - b. Breakdown cause by unauthorized repair, or system modification.
  - c. Breakdown caused by natural disaster or power disorder.

## KOCOM CO.,LTD.

This manual is based on the date as shown in the right and specifications are subject to change without notice for quality improvement.

KIV-202, KIV-D202	05.08
-------------------	-------

# KOCOM

# COLOR HANDS-FREE VIDEO PHONE

KIV-202, KIV-D202 User's Manual for Operation and Installation

- Communication and monitoring by front door camera
- Interactive call and communication between house and guardroom
- Inner line call and communication within the house
- Communication with lobby phone and door open function
- Monitoring of lobby
- For both single house and multi house (Apartments)
- KIV-202 : AC type
- KIV-D202 : DC type

*Thank you very much for purchasing KOCOM video doorphone. please read this manual thoroughly to ensure correct usage, before operating*

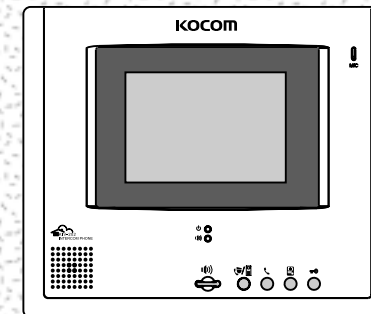

KIV-202 / KIV-D202

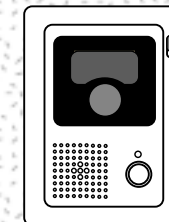

KC-C60

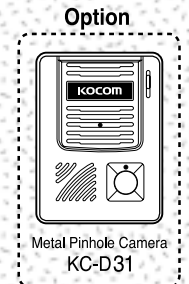

Metal Pinhole Camera  
KC-D31







# Cautions for Safety

For safe use, please stick to the following cautions.

- Read this cautions carefully and keep it within easy reach of you.
- For right installation, read this cautions thoroughly. Please install the product according to its specifications.
- This Cautions for Safety may include items that are not contained in specifications of the product that consumer purchases.
- Reading this cautions, use the product in a right manner. For further information, please contact our A/S center.

## About Symbol

A variety of symbols are used in this Cautions for Safety and your products to guide you to use products in a right and safe manner and to prevent possible risks for users and other persons and damages to their property. The meaning of each symbol is as follows. After fully aware of meaning of each symbol, read the following cautions.

	This symbol means that wrong handling or ignorance of matters that this symbol indicates may cause serious injury or even death of user.
	This symbol means that wrong handling or ignorance of matters that this symbol indicates may cause serious injury or property damage of user.
	This symbol means the matter that user should not do at any event.
	This symbol means that user should follow the instructions.

## Symbols on Drawing



This symbol means that contents (high voltage, electric shock, warnings, etc.) to which user should pay attention are included.



This symbol means that a certain action is not permitted. Specific points not permitted are depicted around this symbol (for example, in the left drawing, disassembly is not permitted.).



This symbol means instructions or is used to force user to do a certain action. Specific instructions are depicted on the drawing (for example, the left drawing instructs user to detach power plug from an outlet).



## Warnings



### Warnings for disposal

- Do not throw used-up battery into fire places, which may cause fire and explosion.



## Cautions



### Cautions for installation

- The relevant law obliges users to have a qualified electrician carry out wiring work for power supply. Work by disqualified persons may cause fire and electric shock.
- Wiring work for communication cables needs techniques and experiences. For this type of wiring work, please consult to your local sales agent.
- According to the standard for electric work and other relevant regulations, install communication cables at the place away from power cables. The failure to install cables separately may cause fire, electric shock and communication troubles.
- Do not install the product on rolling table or sloping place.  
Dropping or falling may cause damage on your product.
- In installation, avoid the place exposed to tremor or shocks, which may cause damages on your product.
- Even if your product is waterproof, do not install it slanted place of water leakage, which may cause a short circuit.
- For the product of wall-mounting type with fixing pegs, keep it safely.  
Fixing pegs may cause injury of user.



- Install the product of wall-mounting type carefully not to drop from the wall. Dropping due to earthquake or tremors may cause injury of user.



- When installing the product on the wall, consider the thickness and material of the wall.  
Dropping in use may cause injury of user.



### Cautions for Use

- Do not put heavy thing on the product. Dropping or falling due to heavy things on it may cause injury of user.



### Cautions for Repairs and Maintenance

- Clean the dust inside the product regularly. Failure to clean the dust for long time may cause fire. For inspection and cleaning of the inside of product, please contact your local sales agent.



- When putting your hands into the inside of equipment, be sure that plug is already detached from an outlet or circuit-breaker is turned off.



- Be careful not to expose the product to benzene, thinner or hot water.
- Do not expose detergent directly to the product in a way of spraying, etc.



- Moving equipment, be sure that the plug is detached from an outlet.
- For equipment whose cables are connected to terminals, please contact your local sales agent or qualified electrician.



- When replacing old fuse with new one, do not directly touch it with bare hands.  
Use insulated tools or contact A/S center.



## Warnings

### Cautions for Use

- Do not install the product at bathroom or at the place near a washing machine, or at other humid places. It may cause fire or electric shock.
- Do not install the product at the place near a dresser, humidifier or heater. Also avoid the place exposed to spark, heat or humidity. All of them may cause fire and electric shock.
- Do not install the product at the place exposed to dust, metals and harmful gas such as hydrogen sulfide gas, all of which may cause fire and electric shock.
- Do not install the product at the place exposed to water and chemicals. This may cause fire and electric shock.
- Do not scratch, break or arbitrarily process power cable, which may cause fire and electric shock. Putting a heavy thing on a cable, heating it or pulling it may cause impairment on it.
- Do not place power cable at the place near heating equipment. It may cause damage of cable's clothing material, which result in fire and electric shock. When detaching from an outlet, do not pull power cable.
- Damages on power cable may cause fire and electric shock. When detaching plug from an outlet, please hold the plug tightly.
- Do not detach plug from an outlet with wet hand. It may cause electric shock.



- When using the existing wiring, be sure of the suitability of it to the product and install the product. Failure to this caution may cause fire.



- When moving equipment, be sure that plug is detached from an outlet and communication cable is disconnected. Damage on cables may cause fire.



- Voltage other than prescribed rated voltage is not permitted, which cause fire and electric shock.
- Do not use power terminal of product's main body in other equipment than prescribed ones. It may cause fire and short-circuit.



- In wiring work, use the designated wiring materials.  
Wiring work using other materials than designated ones may cause fire.



- The equipment without waterproof marking shall not be installed at the place water leaks. It may cause electric shock and short circuit.
- When working, be sure that power is disconnected. Failure to disconnect power may cause electric shock.



- Be sure that the power cable is connected and earths according to designated method. Failure to connection and earth may cause fire.



- Do not connect power to other terminals than designated ones.  
It may cause fire and electric shock.



- When building a system with the product, do not connect the product other equipment than designated one. It may cause fire.



- When installing A/C switch, do work after removing the substance that may cause short circuit or electric shock.  
Before installing or providing A/S service, be sure that the power is disconnected.



## Warnings

### Cautions for Use

- This product is only for home. Do not the product for industrial or military use.
- Do not handle the equipment with wet hand, which may cause electric shock.
- Do not place wet or metallic materials on equipment. Water leakage or intrusion of metallic materials may cause fire and electric shock.
- Do not block the ventilating opening of equipment or put alien substances into it, which may cause fire and electric shock.
- Do not use battery that is not designated or mix new battery with old ones. Insert batteries to fit their polarity. Explosion or leakage of battery may cause fire and injury of user.
- When visitor's image or voice is not displayed on screen or not sounded from speaker, please check his/her identity before opening the door and contact our A/S center.
- Do not use equipment when lightning is expected or strokes. It may cause fire and electric shock.



- Do not open rear cover, cabinet and cover of equipment. It may cause electric shock.



- Do not modify power cable or pull it with excessive strength, which may cause fire and electric shock.
- Do not modify equipment. It may cause fire and electric shock.
- Call signal may cause damage on user's hearing ability.

### Cautions for Abnormality

- When power cable is broken (exposure of core or short-circuit), do not fail to replace broken cable with new one. Failure to replace broken power cable may cause fire and electric shock.
- When detecting any abnormalities in equipment (communication is not available, images do not be displayed on screen, calling is not available, or abnormal sound is heard), immediately detach plug from an outlet, or turn off circuit breaker or detach batteries from equipment (in case that equipment has no plug) before requesting repairs to sales agent or A/S center. Keeping connection to power supply may cause fire and electric shock.
- When alien substances go into equipment, immediately detach plug from an outlet, or turn off circuit breaker or detach batteries from equipment (in case that equipment has no plug) before requesting repair to sales agent or A/S center.
- In the case of smoke or smell of unknown origin from equipment, keeping use it may cause fire and electric shock. Detach plug from an outlet, or turn off circuit breaker or detach batteries from equipment (in case that equipment has no plug) and be sure to check no more smoke or smell from equipment before requesting repair to sales agent or A/S center. Since personal repairing work by user may serious accidents. In any case, do not repair equipment with your own hand.
- When dropping equipment or breaking its cabinet, detach plug from an outlet, or turn off circuit breaker or detach batteries from equipment (in case that equipment has no plug) before requesting repair to sales agent or A/S center. Keeping use equipment may cause fire and electric shock.
- Avoid direct exposure to sunlight and store equipment at the place free from dust and high temperature as you can. High temperature of equipment may cause fire and electric shock.



## Safety Instructions, Warnings, and Cautions of Each System

- This equipment is electronically precision equipment, so do not arbitrarily disassemble it.
- In installation of the product, do not fail to follow the specifications (specifications offered by KOCOM).
- Do not touch the product with alien materials (for example, sticker, magnet, opener, metal chopstick, etc.) or insert them into the product (it may cause reduction of the product's durability and harmful results to user as well).
- In the rainy season, water is likely to penetrate into the product along the wiring. Thus, U-type finishing is recommended as a desirable method of end part finishing.

### System for Multi-unit Housing

- In installation, be careful that other wiring or metallic substances should not contact to the system for multi-unit housing.
- In installation, be careful that alien substances should not go into the system.
- Before installation, be fully aware of wiring specifications of each model.
- In installation, be sure that the length and dimension of wiring meet the requirement prescribed in installation manual.
- Excessive strength and external shock may cause mechanical breakdowns of equipment.
- Do not arbitrarily open the case of the product  
(When user opens the case arbitrarily, KOCOM may reject to provide A/S service).

Lobby Phone: KLP-(100, 104, 108, 112), KLP-(P100, P104, P108, P112), KDP-(100, 104, 108, 112), KLP-(C100, C104, C108, C112)

- A stroke of lightning or strong shock may give fatal and adverse effects on system. Thus, do not fail to ground the system.
- For registration of household password, please refer to user manual of the concerned product (it is applied to ten-key lobby phone products [KLP-100, KLP-P100, KDP-100 and KLP-C100]).

Relay : KVS-104P

- An relay can support up to four households.
- In the case of over four householders, additional relays are needed.

Video Amplifier: KHU-102P

- In installation, follow the specification for image in/output.

### Video Phone

- In assembling the product, be careful that wall-mounting pegs should not contact with wirings.
- In connection of cables, strip its insulation off as much as necessary (Excessive stripping off its insulation may cause short circuit).
- Be careful that signal cables should not be wired with A/C wiring (it may cause poor display quality).
- Do not drop handset (its damage or short-circuit due to drop may make communication impossible).
- When connecting wires to terminals, use standard screwdriver (otherwise, screws may loosen, which will result in disconnection of wiring).
- Do not clean CRT screen with wet towel or cloth. When water penetrates into the product, it may cause short-circuit.  
Do not fail to clean it with dry towel or soft cloth.
- Do not install camera at the place where water penetrates or leaks. Penetration or leakage of water may cause electric shock or short circuit.

### Home Auto: KHV-444/454/446/456

- Do not insert any metallic materials into the inside of fuse cover. It may cause electric shock.
- Do not close ear to speaker. Abrupt call or signal may give harmful effects on user's hearing.
- After turning power on and off, check again that input contents are saved correctly. Otherwise, data may be missed when auto-signal mode operates.
- Use a standard detector. Non-standardized detectors are likely to cause fire due to excessive voltage or current.
- Please install motion detector at a place easily detect the motions of subjects. When detector is installed at a wrong place or obstacles block the front side of detector, it cannot work well.
- When setting night guard mode, be sure that detector should be connected well.
- Sufficiently charge the battery of wireless handset before using it. Be careful that children should not throw battery. Be sure to close battery cover (When children throw or disassemble battery, it may cause serious accidents).
- Be careful that the polarity of the product matches to that of guardroom communication cable. When polarity is reversed, it may cause abnormal operations of the product or apartment system as a whole.

### 4-Line Related Products: KVM-604, 624, 524RG, 524G, 524GS, 520, KCV-346/356

- In wiring work, be careful that wirings should keep away from the wall-mounting pegs or other furniture at regular interval. Contact of wiring with wall-mounting pegs, etc. may cause short-circuit, electric shock and fire (it is applied to all products with wall-mounting pegs).
- Use the prescribed standard wirings. Non-standardized wirings may give adverse effects on operation of product (it is applied to both video phone and CCTV).

### CCTV Camera

- Do not install at noisy places.
- Do not install at the place exposed to electromagnetic waves.  
Excessive electromagnetic waves may cause continuous noise on screen and mechanical troubles.
- When installing camera outdoor, please put it in the outdoor case. Otherwise, when it rains, the camera may be broken or operate incorrectly.
- Install the product at well-ventilated places.
- Do not use the product for medical or military uses.
- Do not install the product at humid places. It may cause reduction of the product's durability as well as fire and electric shock.
- When lens is stained with alien substances, clean it with soft cloth to prevent the damages on it.
- Install the product out of reach of children.

## Precautions for Operation

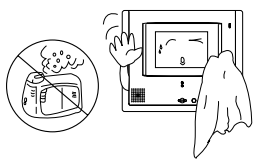

Keep away from humidifier and stove. High temperature and humidity can cause breakdown.

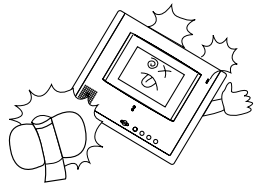

Do not drop monitor or door camera, and avoid strong impact.

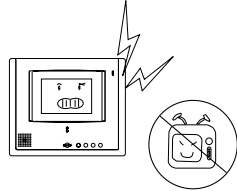

Keep away from devices generating strong magnetic field (TV, Speaker, etc.) (Picture can be disturbed or blurred and breakdown can result)

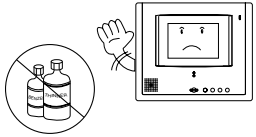

When cleaning, never use wet hands, volatile benzene or paint thinner.

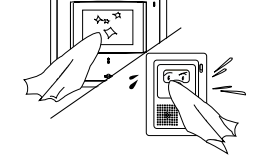

Keep picture clear by cleaning camera window frequently with soft cloths.

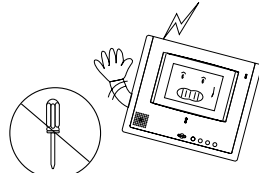

As this device consists of electronic precision components, and high voltage is generated internally, do not attempt to disassemble.

## Installation Precautions

- Monitor and camera must be installed away from direct light and counter light.
- Camera must be installed at a place free from rain.
- Standard height of monitor must be 1,450mm~1,500mm from ground, centered around brown tube.
- Camera should be installed on the wall in which cement is completely dry.
- If installed during winter season at temperature below  $-5^{\circ}$ , condensation might be generated inside monitor and camera due to temperature difference between indoors and outdoors. To prevent breakdown due to such condensation, connection should be made in 2 hours or more after installation.
- Do not install monitor and camera in locations subject to direct heating as harmful gases may subsequently be emitted in significant amounts.

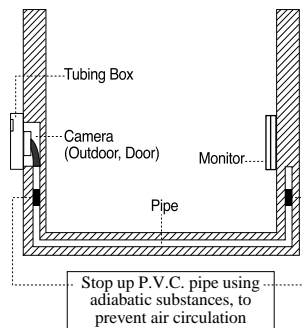

※ Stopping up pipe as above minimizes temperature difference between indoors and outdoors, and also eliminates moisture and condensation on door camera window.

## Component's Name

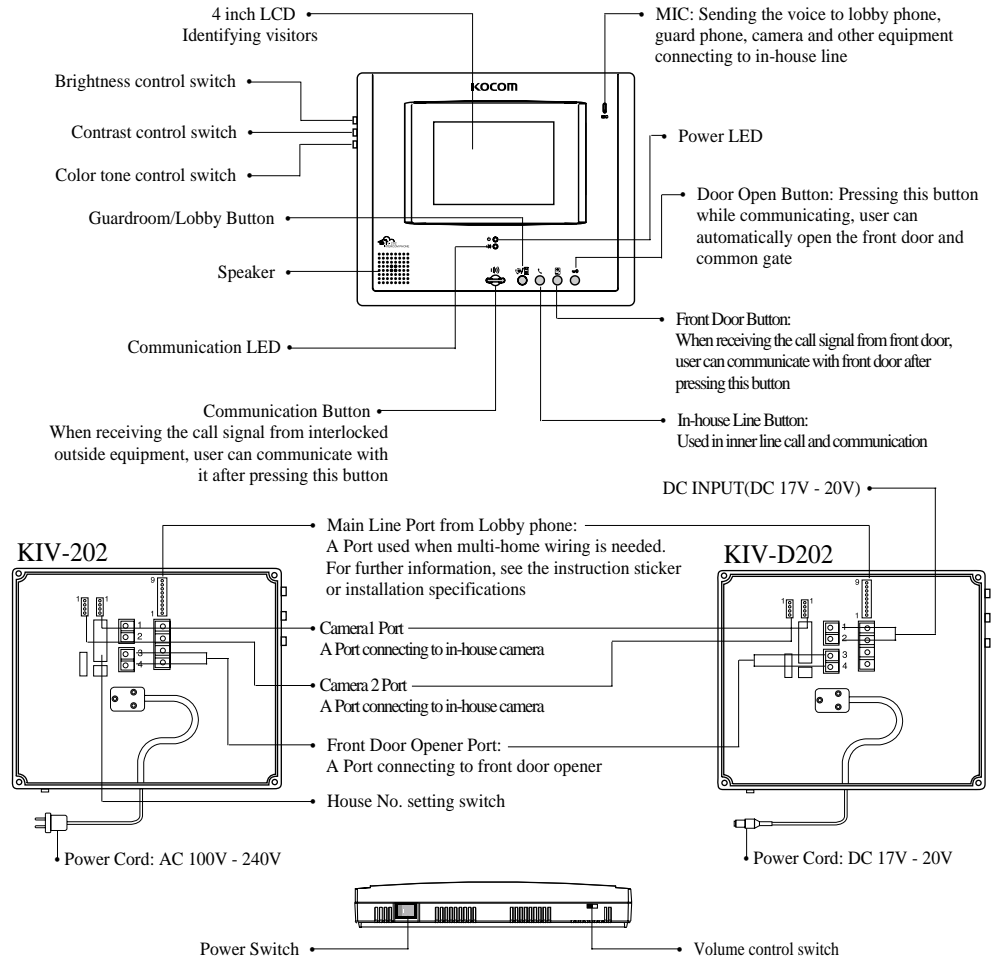

### ■ KC-C60 Camera & KC-D31 Metal Pinhole Camera

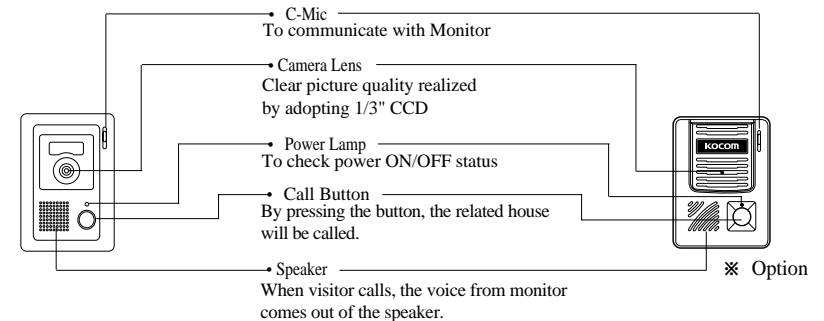

## Monitor Installation

### Basic Installation method of Monitor

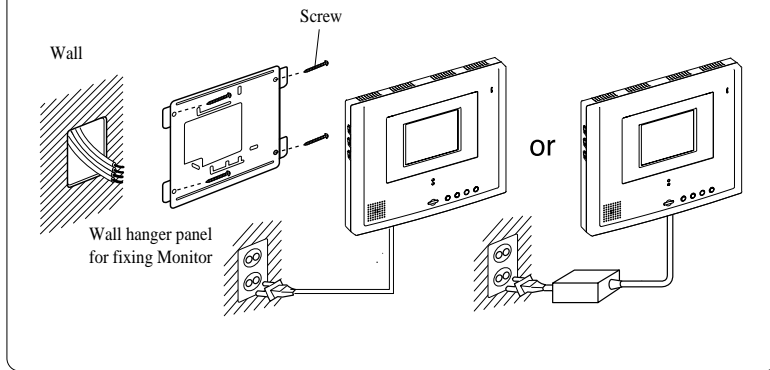

### When system is attached to 1 rectangular switch box

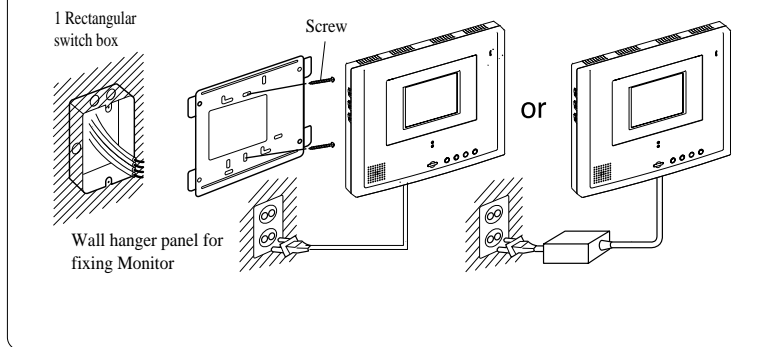

### Standard height monitor

- Standard height of monitor is ranged 1,450 ~ 1,500 from bottom to the center of monitor screen.
- For installation, avoid the places where there is any excessive humidity, magnetic force, dangerous chemicals, direct ray of sun, and any places near a heater which can cause break down.

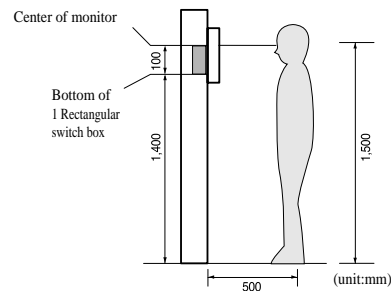

## Door camera Installation

### KC-C60 Surface-mounting Door Camera Installation

#### Straight Ahead Installation

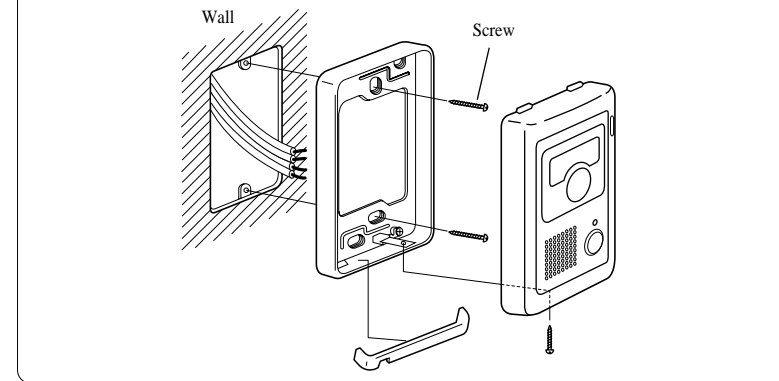

※ Before installation, do not fail to shut the piping.

### Standard Height of Door Camera

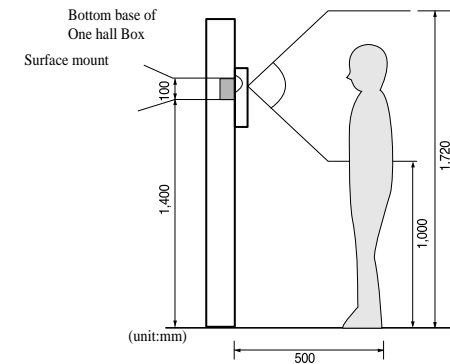

- Standard height of the door camera is 1,400mm ~ 1,450mm from the bottom of one camera to the floor.
- In case that the height of Door camera exceeds the range of min. 1,250mm~1,550mm, it is impossible to control the screen picture with only the lens angle, and therefore, be careful of the height of camera installation.

## Component

### ■ Monitor Components

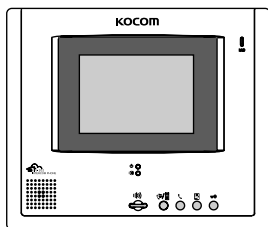

● Monitor

### ■ Monitor Accessories

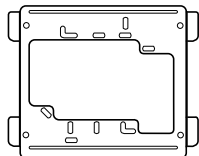

① A Wall Hanger Frame



② Wall Hanger Fixing Screws

### ③ Wiring Lines of Camera 1 & 2



Blue (Power)  
Yellow (GND)  
Red (Voice)  
White (Video)

### ④ Wiring Lines of Multi-home Main Line



Gray (+17V)  
Violet (GND)  
Blue (Voice)  
Green (Voice)  
Yellow (Video Input)  
Orange (Data)  
Red (In-house Line)  
Brown (Data in-house line)  
Black (Video Output)

### ■ Front Door Camera Components

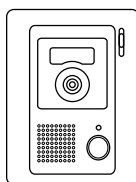

● Camera

### ① Camera Main Frame Supporter

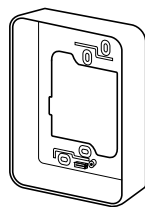

② Screws for fixing camera to main frame supporter

③ Screws for fixing cabinet body on the wall

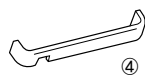

④ Upward adjusting supporter for lens angle

## Product Specifications

### ■ KIV-202 Monitor / KIV-D202 Monitor

**Power Source** AC 100V - AC 240V / DC 17V - DC 20V(Stand-by: Min 4.8W, Operation: Max 19W)

**Voltage of Operating Power** DC +12.8V

**Lobby / Guardroom / In-house Call Signal** Call Signal (Electronic Tone Sound)

**Monitoring of Front Door Camera** User can monitor situations of front door camera using "Front Door" button on monitor.

**Lobby Phone's Lobby** By pressing "Guard/Lobby" button for about 5 seconds, users can monitor lobby situations

**Monitoring Function** (This function is available only in lobby phones adopting TEN-KEY [KLP-100 series] mode).

**Call Method** When pressing call button on outdoor camera, call signal rings.

Explanation for melody type of front door camera :

- Camera 1 : 'Ding-Dong~' 2times

- Camera 2 : 'Ddiriri~' 8times

**Communication Method** Hands-free System (DSP)

**Image Maintenance Time** In calling from front door camera, image maintains for about 30 seconds.

While communicating, image maintains for about 3 minutes.

**Number of Wiring** Front Door Camera: 4-wire Polarity IV 0.65mm or more

Main line: VOICE1/VOICE2/DATA(3-line) Polarity IV 0.8mm or more

Power (+/GND) (2-line) Polarity IV 1.2mm or more

For video line, coaxial cable is used - COAXIAL 5C-2V

**Dimensions** 237(W) X 199(H) X 39(D) mm

**Communication Distance** Front Door Camera: When 0.65mm cable is used, 30m

Main Line Communication Line: When IV 0.8Φ is used, 300m

**Guaranteed Operation Temperature** Monitor: 0.C ~ 50.C

### ■ KC-C60, KC-D31 Front Door Camera

	CAMERA (KC-C60)	Metal Pinhole Camera (KC-D31)
<b>Power Source</b>	DC12V ± 1V(Power from monitor)	
<b>Ambient temperature</b>	-10°C ~ 50°C	
<b>Angle of picture</b>	Diagonal 120°	Diagonal 90°
<b>Min. Illumination</b>	0.1Lux(LED ON)	
<b>Lens</b>	F:2.0, f=3.0mm	F:3.5, f=3.8mm
<b>Dimension</b>	95(W) X 127(H) X 34(D)mm	95(W) X 127(H) X 33(D)mm

## Wiring Diagram

### ■ Wiring for single house without lobby phone connection

#### ※ Cautions

1. Pin No.1, 2, 7 & 8 in Main Line Port should be connected between main and sub monitor for internal call and communication.
2. For the connection with KIP-603, please refer to the wiring diagram in multi houses (apartment) in next.
3. In extension with KIP-603 (Audio phone), it is not available to make conversation with front door camera.
4. The DIP switch in sub unit should be set as "0".

#### ※ Cautions

##### - Door lock connection

Only one door lock should be installed and connected to the monitor for front door open. (single house use)  
If 2 door locks are installed in parallel connection, these 2 doors will be open at same time.

##### - Front door camera connection

Be careful in camera connection to the camera ports. As the camera ports have different 2 call sounds, if camera 1 is connected to the camera port 1 in main monitor and to the camera port 2 in sub monitor, main monitor and sub monitor have different 2 call sounds. And camera 1 has 2 different call back tones, too.

##### - Call sounds : Camera 1 - 'Ding~Dong~' 2 times.

Camera 2 - 'Ddiriri~' 8 times.

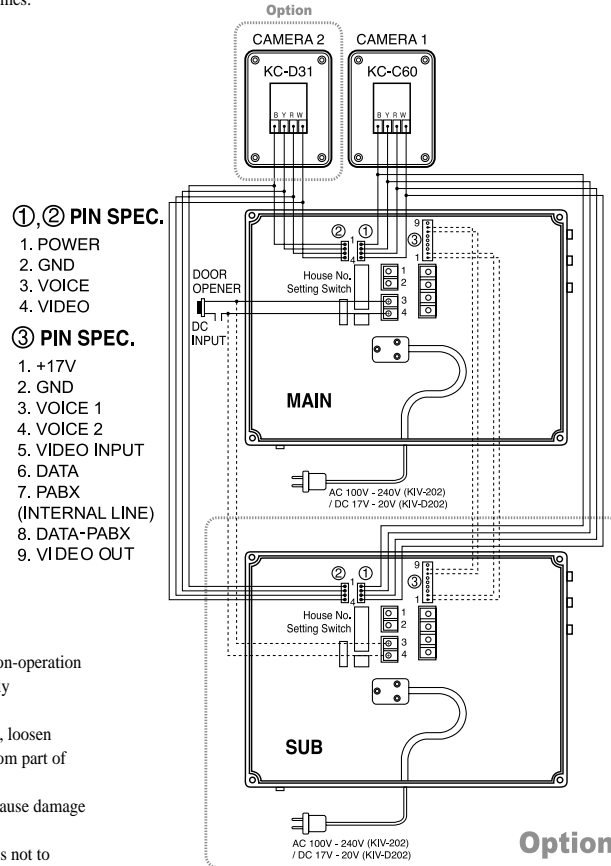

### Precautions for Wiring

- As incorrect wiring may cause the device's non-operation or poor communication quality, please carefully conduct wiring work.
- When connecting a wiring chord to a terminal, loosen screw, insert the end of the chord into the bottom part of screw, and tighten the screw.
- When fixing wiring chord, use stapler not to cause damage to the chord.
- When using existing wiring, please be cautious not to cause disconnection and short-circuit.

## Wiring Diagram

### ■ Wiring for multi houses (apartment) using KLP-C100 series Lobby phone

- Video phone to Video phone wiring in a house.

#### ※ Cautions

1. Pin No.6 (data line) in Main Line Port is not connected in sub video phone.
2. Pin No.1, 2, 3, 4, 5, 7 & 8 in Main Line Port are used in a form of parallel connection between main monitor and sub monitor.
3. The DIP switch in sub unit should be set as "0".

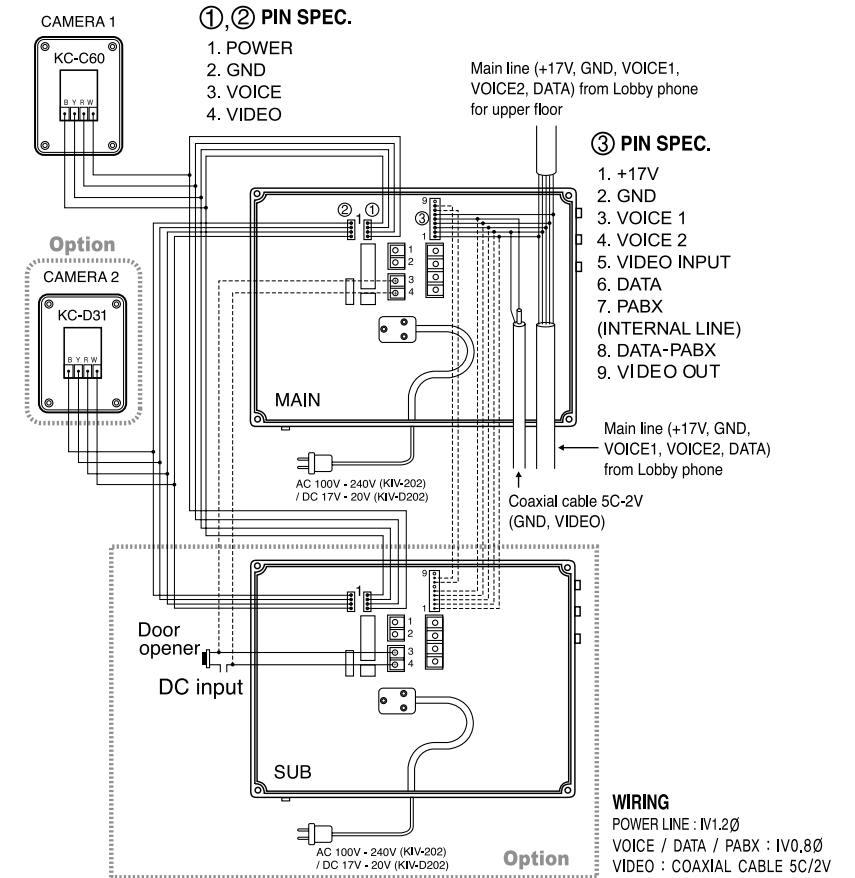

#### ※ Cautions

##### - Door lock connection

Only one door lock should be installed and connected to the monitor for front door open. (single house use)  
If 2 door locks are installed in parallel connection, these 2 doors will be open at same time.

##### - Front door camera connection

Be careful in camera connection to the camera ports. As the camera ports have different 2 call sounds, if camera 1 is connected to the camera port 1 in main monitor and to the camera port 2 in sub monitor, main monitor and sub monitor have different 2 call sounds. And camera 1 has 2 different call back tones, too.

- Call sounds : Camera 1 - 'Ding~Dong~' 2 times. Camera 2 - 'Ddiriri~' 8 times.



- Wiring for multi houses (apartment) using KLP-C100 series Lobby phone
  - Video phone to Audio phone wiring in a house.

※ Cautions

1. Terminal No. 5(data line) in sub audio phone is not connected from Pin No. 6(data line) of main monitor.
2. Pin No. 1, 2, 3, 4, 7 & 8 in Main Line Port (Monitor) are used in a form of parallel connection between main monitor and sub audio phone (1, 2, 3, 4, 6, 7).
3. In extension with KIP-603 (Audio phone), it is not available to make conversation with the front door camera.
4. The DIP switch in sub unit should be set as "0".

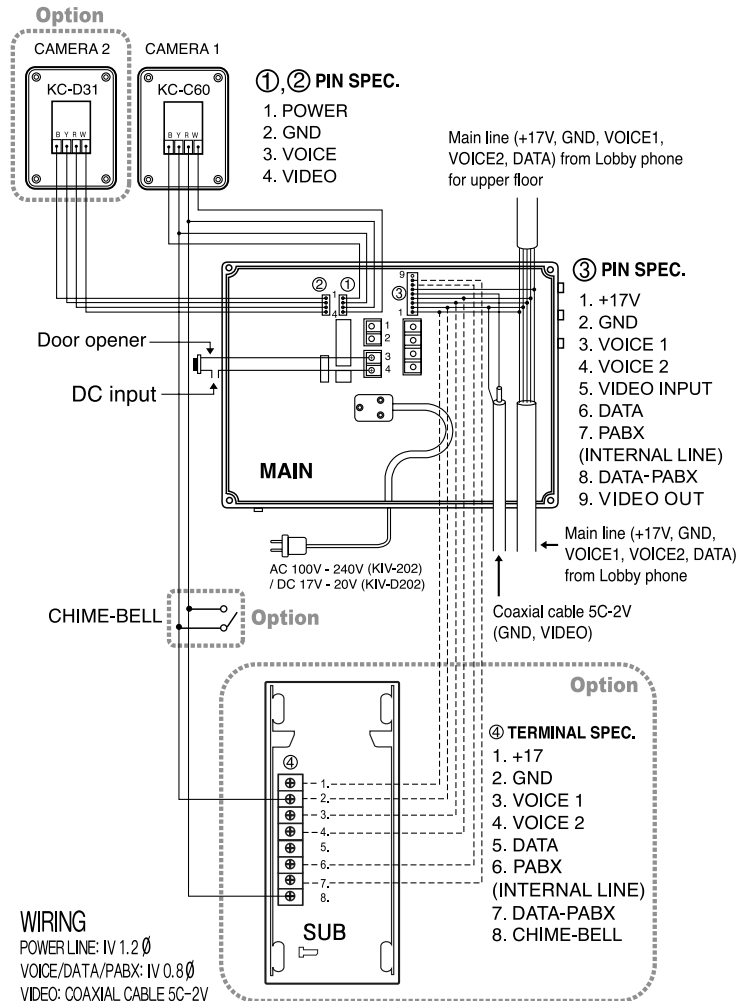

※ Communication between front door camera and audio phone is unavailable.

## Instructions for Operation

### ■ Functional Descriptions

#### ▷ Communication with front door when a visitor comes:

When a visitor presses the call button of front door camera,

1. Call signal rings at home monitor and its screen is automatically turned on to display a visitor.
2. If pressing communication button or front door button on the front side of videophone, user can communicate with the visitor at front door.  
(The monitor screen will be automatically faded out after 30 seconds)
3. If pressing communication button or front door button again after communication with the visitor, user can end the communication (and screen is also faded out). If user wants to keep communicating, press front door button again to connect to front door camera and then press communication button .

By doing so, monitor screen is turned on and user can keep communicating with the visitor. (While communicating with the visitor, if user presses the door open button , house front door will be opened.)



#### ▷ Monitoring of Front Door Situations

1. Monitoring for Camera 1
  - If pressing the front door button once on the monitor, the image from camera 1 port is displayed on the monitor screen.
2. Monitoring for Camera 2
  - If pressing the front door button once on the monitor, the image from camera 1 port is displayed on the monitor screen. And if pressing the front door button once again, the image from camera 2 port is displayed on the monitor screen. Then, if pressing the front door button once again, the monitor screen is turned off.
3. In case only one camera is installed
  - If pressing the front door button , the image is displayed on the monitor screen. If pressing once again, there will be no image displayed on the monitor screen.
  - In case camera 1 is connected to the camera port 2 at the back of the monitor. If pressing the front door button once, there is no image displayed and then if pressing once again, the image from camera port 2 is displayed. In this case, if you change the camera 2 port to 1 port, it will work in normal.
4. In case two cameras are installed.
  - If pressing the front door button once, the image from camera 1 is displayed and if pressing once again, the image from camera 2 is displayed. If pressing one more, the monitor screen is turned off.
  - Cautions : Be careful for wrong connection between cameras and camera ports.







#### ▷ Call from Guardroom - How to communicate

1. If the guard calls to the house, tone sound rings and both communication and guard/lobby LED flicker at the front side of videophone.
2. When user presses communication or guard/lobby button , communication begins.
3. When user presses communication or guard/lobby button again, communication is ended.

### ▷ Call to guardroom - How to communicate

1. When user presses guard/lobby button , call signal rings and the button's LED is turned on to call guardroom phone.
2. If handset is picked up in guardroom phone, communication begins (for up to 3 minutes).
3. If hanging up the handset in guardroom or pressing communication  or guard/lobby button  on videophone, and communication will be automatically ended.

### ▷ Call from lobby phone - How to communicate





1. When a call from lobby phone, both communication  and guard/lobby buttons  flicker (tone sound rings for 30 seconds).
2. Press communication  or guard/lobby buttons , and communication will be available (communication lasts for 3 minutes).
3. Press door open button  on videophone while communicating with lobby phone to operate common gate opener.
4. Press either communication  or guard/lobby button  to end communication.

### ▷ Monitoring of Lobby (Common Gate) Situations





1. If pressing the guard/ lobby button  around 3 sec. on the monitor for about 3sec, the image from lobby phone (common gate camera) is displayed on the monitor screen.  
But in case the lobby phone (common gate camera) or guardroom phone is busy, the image from lobby phone (common gate camera) is not displayed.
2. After 8 sec. of lobby (common gate) monitoring, the monitor screen is automatically turned off.
3. In house, the users can see the image and hear the voice from the lobby phone (common gate camera) for 8 sec.
4. This lobby (common gate) monitoring function is only available with 10 key type of KLP-100, KLP-P100 & KLP-C100 lobby phone (common gate camera).

※ **Communication is available only when options are installed. If options are not installed, only tone sounds rings.**

### ▷ Call from In-house Line (When options are installed)

1. When internal call signal, in-house line LED at the front side of videophone flickers.
2. Press either communication  or in-house line button  to start communication (LED keeps On-mode).
3. Communication is available for up to 3 minutes. When 3 minutes pass, communication is automatically ended.
4. Press either communication  or in-house line  to end communication.

### ▷ Internal Call using In-house Line (When options are installed)

1. When user presses in-house line button , the button's LED flicker and a call signal is sent to extended unit.
2. Press communication  or in-house line button  on extended unit to begin communication (communication maintains for 3 minutes).
3. Press communication  or in-house line button  to end communication.

- ※ Users can control chime volume by adjusting 3-level volume switch on videophone.
- ※ In all functions, call maintenance time is set for 30 seconds. After 30 seconds, call signal and images return to stand-by mode.
- ※ All communications maintains for 3 minutes. After 3 minutes, communication automatically returns to stand-by mode.

## ■ Instructions for Operation

**Model: (KLP-100 / KLP-P100 / KLP-C100), Functional Specifications**

### ▷ Call to house

When a visitor calls to house using lobby phone, press house number.

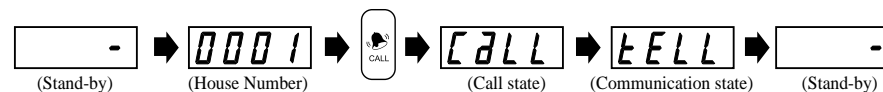

- > Pressing call button, call sound rings and house is called.
- > If the house responds to the call, communication is available for 3 minutes.  
(Pressing door open button during the communication, opener installed with common gate is opened.)
- > When communication is ended, device returns to standby mode.

### ▷ Call from lobby phone to guardroom

Pressing "0" and call button on the lobby phone, guardroom is called and lobby phone ID is displayed in guardroom phone.

- > Communication with guardroom maintains (for 3 minutes). When communication is ended, device returns to standby mode.

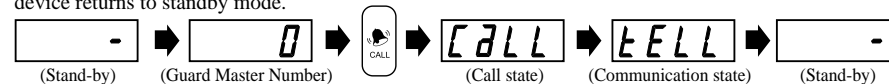

### ▷ Password Change

(Password change function is only available during the call with house.)

Pressing "# # 0 0 #" during the call with house, " - - - - " is displayed.

Input new password and press "#" button.

e.g) When register password as '1111'. (It should be 4 digits)

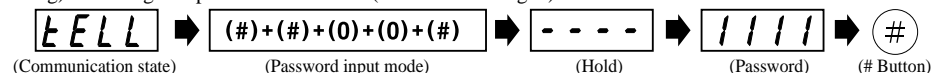

### ▷ Door open using lobby phone with password

Pressing "house number + # + password + #" designated by the house, door is automatically opened.

when the user from house number "0101" opens common gate with password.

e.g) Press house number "0101", #, password and # in order.



### [Lobby Phone's Direct-Button Call Function]

**Model : KLP-104, 108, 112, KLP-P104, P108, P112, KLP-C104, C108, C112**

**To call to house, press house number using lobby phone's key pad.**

Tone sound rings and call signal is sent to the house.

Pressing the call button again while calling, calling is cancelled. No separate cancel button is offered.

If called house is communicating with extended other lobby phones or guardroom phone, busy signal sounds and device immediately returns to stand-by mode.

### ▷ Operation of Door Opener While Communicating with House

1. Pressing door open button during the communication with house, common gate is opened.  
(Door Opener Specification: Within DC 12V 300mA)

※ Functional specifications may be changed according to the specifications of installed products.

# DIP Switch Setting at House Interphone and Video Phone

e.g. 1)

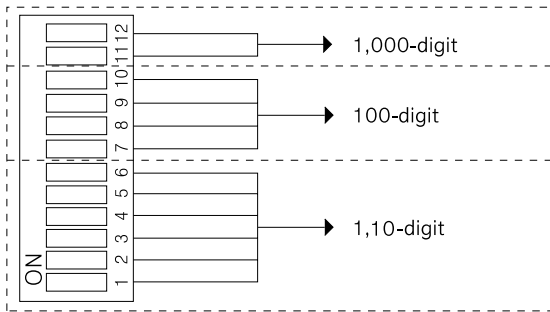

e.g. 2)

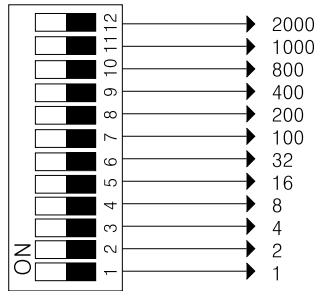

Numbers by the figure indicate the number set when all switches move toward ON direction.

1. Above figure, turning all DIP switches from No.1 to No. 12 toward ON direction, numbers set by DIP switches are summed up.

e.g. 1) Above figure, turning switch No.1 and No. 2 toward On direction, value is set at 3 (1 + 2 = 3) since numbers set by switches are 1 and 2.

e.g. 2) Above figure, turning switch No.1 and No. 3 toward On direction, value is set at 5 (1 + 4 = 5) since numbers set by switches are 1 and 4.

e.g. 3)

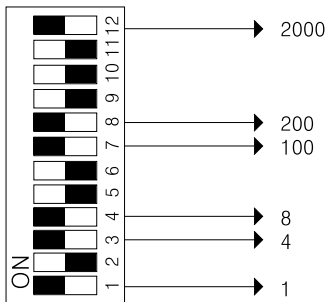

As shown in the left figure, turning DIP switch No. 1, 3, 4, 7, 8 and 12 toward ON direction, the resultant value is calculated as follows.  
 $1 + 4 + 8 + 100 + 200 + 2,000 = \text{House No. 2313}$

e.g. 4)

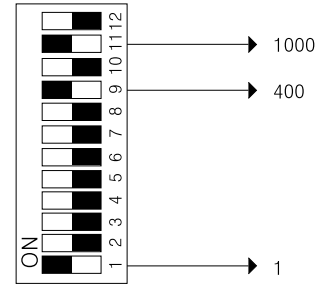

e.g. 3) As shown in the left figure, turning DIP switch No. 1, 9 and 11 toward ON direction, the resultant value is calculated as follows.  
 $1 + 400 + 1,000 = \text{House No. 1401}$

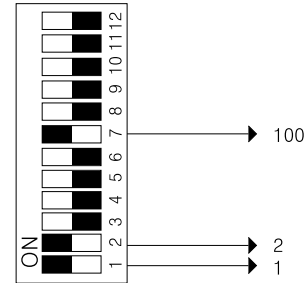

e.g. 3) As shown in the left figure, turning DIP switch No. 1, 2 and 7 toward ON direction, the resultant value is calculated as follows.  
 $1 + 2 + 100 = \text{House No. 103}$

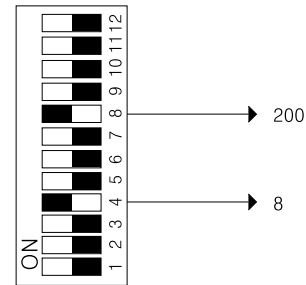

e.g. 3) As shown in the left figure, turning DIP switch No. 4 and 8 toward ON direction the resultant value is calculated as follows.  
 $8 + 200 = \text{House No. 208}$

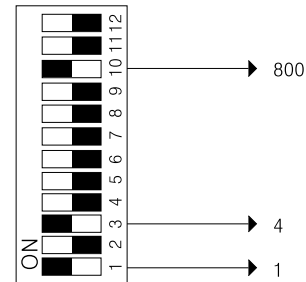

e.g. 3) As shown in the left figure, turning DIP switch No. 1, 3 and 10 toward ON direction, the resultant value is calculated as follows.  
 $1 + 4 + 800 = \text{House No. 805}$

2. For basement floors, DIP switch No. 11 and 12 are generally set toward ON direction.

In this case, the value of DIP switch setting is 3,000 (1,000 + 2,000). However, program uses "8" with similar shape of "B" (Basement) to indicate basement floors. Thus, value is not 3,000 but 8,000.

ex4)

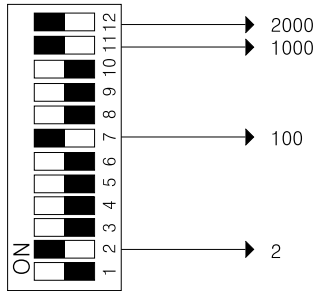

As shown in the left figure, turning DIP switch No. 2, 7, 11 and 12 toward ON direction, the resultant value is calculated as follows.  
 $2 + 100 + 1,000 + 2,000 = \text{House No. B102}$

3. If DIP switches are set as in the above example, press "8102" to call the house using guardroom master or lobby phone.

In addition, house number is displayed as small character "b102" in FND of guardroom master or lobby phone.

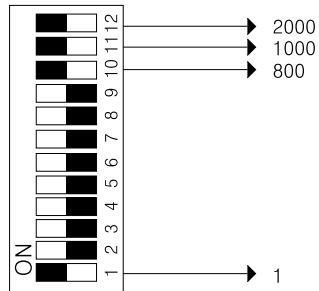

As shown in the left figure, turning DIP switch No. 1, 10, 11 and 12 toward ON direction, the resultant value is calculated as follows.  
 $1 + 800 + 1,000 + 2,000 = \text{House No. b801}$

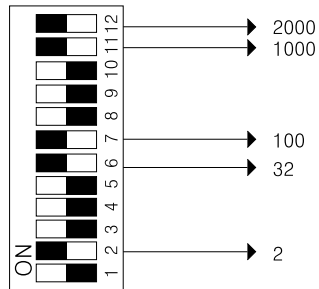

As shown in the left figure, turning DIP switch No. 2, 6, 7, 11 and 12 toward ON direction, the resultant value is calculated as follows.  
 $2 + 32 + 100 + 1,000 + 2,000 = \text{House No. b134}$

#### 4. Precautions for DIP Switch Setting (House No. Setting)

1) After setting DIP switches, device power should be reset.

(In power switch ON state, DIP switches cannot be set.)

2) For setting basement floors, switch No. 11 and 12 should be ON state.

3) For direct button type lobby phone, up to 12 houses can be set.

Thus, when DIP switches of house interphone and video phone are set, available houses are also 1 to 12 in number.

For Common gate panel (KDP-104/KDP-108/KDP-112) and Lobby Phone (KLP-104/KLP-108/KLP-112, KLP-C104/KLP-C108/KLP-C112, KLP-P104/KLP-P108/KLP-P112), house (KVM-520 and KIP-603, KIV-102, KIV-D102, KIV-202, KIV-D202) No. setting should be conducted as following instructions.

(A specification preset by internal protocol)

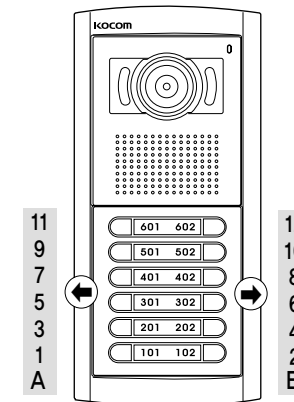

#### House No. (DIP Switch) Setting for direct button type.

House Setting No.

	Lobby Phone (Column A)	Lobby phone (Column B)	Household monitor setting number
KDP-104	1 (101)		1
KLP-104		2 (102)	2
KLP-P104	3 (201)		3
KLP-C104		4 (202)	4
KDP-108	5 (301)		5
KLP-108		6 (302)	6
KLP-P108	7 (401)		7
KLP-C108		8 (402)	8
KDP-112	9 (501)		9
KLP-112		10 (502)	10
KLP-P112	11 (601)		11
KLP-C112		12 (602)	12

(Warning!) House device should be set as described above (Fix house No. type).

4) If user wants to use interphone or video phone as sub-phone, all DIP switches should be in OFF state.

5) When user sets DIP switches, excessive impact on DIP switches may cause abnormal or erroneous operation of device.