

Warranty



To receive after-Sale service, have the following ready when you contact our branches

1. Name of the product
2. Model number of the product
3. The area of problem
4. Phone number and address at which you can be contacted.

Warranty Card

PRODUCT	
MODEL	
DATE PURCHASED	
WARRANTY PERIOD	
AGENCY ADDRESS	

■ KOCOM Warranties the original purchaser of this product as follows.

- 1) This product is produced under strict quality control and inspection procedures.
- 2) If this product breaks down during proper use as a result of product defect, KOCOM will repair it within one year from date of purchase free of charge.
- 3) The following cases will be subject to charge, even during warranty period:
 - a. Breakdown during transport, or through careless treatment, by consumer.
 - b. Breakdown cause by unauthorized repair, or system modification.
 - c. Breakdown caused by natural disaster or power disorder.

KOCOM CO.,LTD.

This manual is based on the date as shown in the right and specifications are subject to change without notice for quality improvement.

KCV-350 05.05

KOCOM

Color Hands-Free Videophone

KCV-350 / KCV-D350 User's Manual for Operation and Installation

- Communication with and monitoring by front door camera
- 3.5 inch TFT LCD
- MAX. 2 Monitors parallel connectable with a camera
- 4 wired in polarity
- Wide view angle
- Hands-Free type

Thank you very much for purchasing KOCOM videophone. please read this manual thoroughly to ensure correct usage, before operating

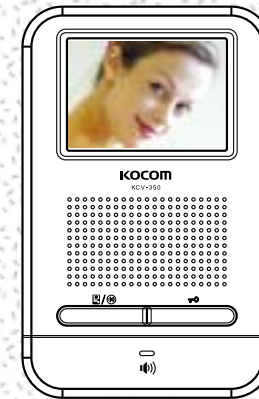

KCV-350 / KCV-D350

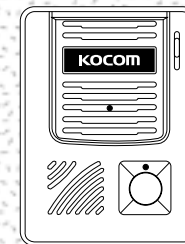

KC-D32







Cautions for Safety

For safe use, please stick to the following cautions.



- Read this cautions carefully and keep it within easy reach of you.
- For right installation, read this cautions thoroughly. Please install the product according to its specifications.
- This Cautions for Safety may include items that are not contained in specifications of the product that consumer purchases.
- Reading this cautions, use the product in a right manner. For further information, please contact our A/S center.

About Symbol

A variety of symbols are used in this Cautions for Safety and your products to guide you to use products in a right and safe manner and to prevent possible risks for users and other persons and damages to their property. The meaning of each symbol is as follows. After fully aware of meaning of each symbol, read the following cautions.

	This symbol means that wrong handling or ignorance of matters that this symbol indicates may cause serious injury or even death of user.
	This symbol means that wrong handling or ignorance of matters that this symbol indicates may cause serious injury or property damage of user.
	This symbol means the matter that user should not do at any event.
	This symbol means that user should follow the instructions.

Symbols on Drawing

-  This symbol means that contents (high voltage, electric shock, warnings, etc.) to which user should pay attention are included.
-  This symbol means that a certain action is not permitted. Specific points not permitted are depicted around this symbol (for example, in the left drawing, disassembly is not permitted.).
-  This symbol means instructions or is used to force user to do a certain action. Specific instructions are depicted on the drawing (for example, the left drawing instructs user to detach power plug from an outlet).



Warnings



Warnings for disposal

- Do not throw used-up battery into fire places, which may cause fire and explosion.



Cautions



Cautions for installation

- The relevant law obliges users to have a qualified electrician carry out wiring work for power supply. Work by disqualified persons may cause fire and electric shock.
- Wiring work for communication cables needs techniques and experiences. For this type of wiring work, please consult to your local sales agent.
- According to the standard for electric work and other relevant regulations, install communication cables at the place away from power cables. The failure to install cables separately may cause fire, electric shock and communication troubles.
- Do not install the product on rolling table or sloping place.
Dropping or falling may cause damage on your product.
- In installation, avoid the place exposed to tremor or shocks, which may cause damages on your product.
- Even if your product is waterproof, do not install it slanted place of water leakage, which may cause a short circuit.
- For the product of wall-mounting type with fixing pegs, keep it safely.
Fixing pegs may cause injury of user.



- Install the product of wall-mounting type carefully not to drop from the wall. Dropping due to earthquake or tremors may cause injury of user.



- When installing the product on the wall, consider the thickness and material of the wall.
Dropping in use may cause injury of user.



Cautions for Use

- Do not put heavy thing on the product. Dropping or falling due to heavy things on it may cause injury of user.



Cautions for Repairs and Maintenance

- Clean the dust inside the product regularly. Failure to clean the dust for long time may cause fire. For inspection and cleaning of the inside of product, please contact your local sales agent.



- When putting your hands into the inside of equipment, be sure that plug is already detached from an outlet or circuit-breaker is turned off.



- Be careful not to expose the product to benzene, thinner or hot water.
- Do not expose detergent directly to the product in a way of spraying, etc.



- Moving equipment, be sure that the plug is detached from an outlet.
- For equipment whose cables are connected to terminals, please contact your local sales agent or qualified electrician.



- When replacing old fuse with new one, do not directly touch it with bare hands.
Use insulated tools or contact A/S center.



Warnings

Cautions for Use

- Do not install the product at bathroom or at the place near a washing machine, or at other humid places. It may cause fire or electric shock.
- Do not install the product at the place near a dresser, humidifier or heater. Also avoid the place exposed to spark, heat or humidity. All of them may cause fire and electric shock.
- Do not install the product at the place exposed to dust, metals and harmful gas such as hydrogen sulfide gas, all of which may cause fire and electric shock.
- Do not install the product at the place exposed to water and chemicals. This may cause fire and electric shock.
- Do not scratch, break or arbitrarily process power cable, which may cause fire and electric shock. Putting a heavy thing on a cable, heating it or pulling it may cause impairment on it.
- Do not place power cable at the place near heating equipment. It may cause damage of cable's clothing material, which result in fire and electric shock. When detaching from an outlet, do not pull power cable.
- Damages on power cable may cause fire and electric shock. When detaching plug from an outlet, please hold the plug tightly.
- Do not detach plug from an outlet with wet hand. It may cause electric shock.



- When using the existing wiring, be sure of the suitability of it to the product and install the product. Failure to this caution may cause fire.



- When moving equipment, be sure that plug is detached from an outlet and communication cable is disconnected. Damage on cables may cause fire.



- Voltage other than prescribed rated voltage is not permitted, which cause fire and electric shock.
- Do not use power terminal of product's main body in other equipment than prescribed ones. It may cause fire and short-circuit.



- In wiring work, use the designated wiring materials.
Wiring work using other materials than designated ones may cause fire.



- The equipment without waterproof marking shall not be installed at the place water leaks. It may cause electric shock and short circuit.
- When working, be sure that power is disconnected. Failure to disconnect power may cause electric shock.



- Be sure that the power cable is connected and earths according to designated method. Failure to connection and earth may cause fire.



- Do not connect power to other terminals than designated ones.
It may cause fire and electric shock.



- When building a system with the product, do not connect the product other equipment than designated one. It may cause fire.



- When installing A/C switch, do work after removing the substance that may cause short circuit or electric shock.
Before installing or providing A/S service, be sure that the power is disconnected.



Warnings

Cautions for Use

- This product is only for home. Do not the product for industrial or military use.
- Do not handle the equipment with wet hand, which may cause electric shock.
- Do not place wet or metallic materials on equipment. Water leakage or intrusion of metallic materials may cause fire and electric shock.
- Do not block the ventilating opening of equipment or put alien substances into it, which may cause fire and electric shock.
- Do not use battery that is not designated or mix new battery with old ones. Insert batteries to fit their polarity. Explosion or leakage of battery may cause fire and injury of user.
- When visitor's image or voice is not displayed on screen or not sounded from speaker, please check his/her identity before opening the door and contact our A/S center.
- Do not use equipment when lightning is expected or strokes. It may cause fire and electric shock.



- Do not open rear cover, cabinet and cover of equipment. It may cause electric shock.



- Do not modify power cable or pull it with excessive strength, which may cause fire and electric shock.
- Do not modify equipment. It may cause fire and electric shock.
- Call signal may cause damage on user's hearing ability.

Cautions for Abnormality

- When power cable is broken (exposure of core or short-circuit), do not fail to replace broken cable with new one. Failure to replace broken power cable may cause fire and electric shock.
- When detecting any abnormalities in equipment (communication is not available, images do not be displayed on screen, calling is not available, or abnormal sound is heard), immediately detach plug from an outlet, or turn off circuit breaker or detach batteries from equipment (in case that equipment has no plug) before requesting repairs to sales agent or A/S center. Keeping connection to power supply may cause fire and electric shock.
- When alien substances go into equipment, immediately detach plug from an outlet, or turn off circuit breaker or detach batteries from equipment (in case that equipment has no plug) before requesting repair to sales agent or A/S center.
- In the case of smoke or smell of unknown origin from equipment, keeping use it may cause fire and electric shock. Detach plug from an outlet, or turn off circuit breaker or detach batteries from equipment (in case that equipment has no plug) and be sure to check no more smoke or smell from equipment before requesting repair to sales agent or A/S center. Since personal repairing work by user may serious accidents. In any case, do not repair equipment with your own hand.
- When dropping equipment or breaking its cabinet, detach plug from an outlet, or turn off circuit breaker or detach batteries from equipment (in case that equipment has no plug) before requesting repair to sales agent or A/S center. Keeping use equipment may cause fire and electric shock.
- Avoid direct exposure to sunlight and store equipment at the place free from dust and high temperature as you can. High temperature of equipment may cause fire and electric shock.



Safety Instructions, Warnings, and Cautions of Each System

- This equipment is electronically precision equipment, so do not arbitrarily disassemble it.
- In installation of the product, do not fail to follow the specifications (specifications offered by KOCOM).
- Do not touch the product with alien materials (for example, sticker, magnet, opener, metal chopstick, etc.) or insert them into the product (it may cause reduction of the product's durability and harmful results to user as well).
- In the rainy season, water is likely to penetrate into the product along the wiring. Thus, U-type finishing is recommended as a desirable method of end part finishing.

System for Multi-unit Housing

- In installation, be careful that other wiring or metallic substances should not contact to the system for multi-unit housing.
- In installation, be careful that alien substances should not go into the system.
- Before installation, be fully aware of wiring specifications of each model.
- In installation, be sure that the length and dimension of wiring meet the requirement prescribed in installation manual.
- Excessive strength and external shock may cause mechanical breakdowns of equipment.
- Do not arbitrarily open the case of the product
(When user opens the case arbitrarily, KOCOM may reject to provide A/S service).

Lobby Phone: KLP-(100, 104, 108, 112), KLP-(P100, P104, P108, P112), KDP-(100, 104, 108, 112)

- A stroke of lightning or strong shock may give fatal and adverse effects on system. Thus, do not fail to ground the system.
- For registration of household password, please refer to user manual of the concerned product (it is applied to ten-key lobby phone products [KLP-100, KLP-P100 and KDP-100]).

Image Splitter: KSV-104P

- An image splitter can support up to four households.
- In the case of over four householders, additional image splitters are needed.

Image Amplifier: KHU-102P

- In installation, follow the specification for image in/output.

Video Phone

- In assembling the product, be careful that wall-mounting pegs should not contact with wirings.
- In connection of cables, strip its insulation off as much as necessary (Excessive stripping off its insulation may cause short circuit).
- Be careful that signal cables should not be wired with A/C wiring (it may cause poor display quality).
- Do not drop handset (its damage or short-circuit due to drop may make communication impossible).
- When connecting wires to terminals, use standard screwdriver (otherwise, screws may loosen, which will result in disconnection of wiring).
- Do not clean CRT screen with wet towel or cloth. When water penetrates into the product, it may cause short-circuit.
Do not fail to clean it with dry towel or soft cloth.
- Do not install camera at the place where water penetrates or leaks. Penetration or leakage of water may cause electric shock or short circuit.

Home Auto: KHV-444/454/446/456

- Do not insert any metallic materials into the inside of fuse cover. It may cause electric shock.
- Do not close ear to speaker. Abrupt call or signal may give harmful effects on user's hearing.
- After turning power on and off, check again that input contents are saved correctly. Otherwise, data may be missed when auto-signal mode operates.
- Use a standard detector. Non-standardized detectors are likely to cause fire due to excessive voltage or current.
- Please install motion detector at a place easily detect the motions of subjects. When detector is installed at a wrong place or obstacles block the front side of detector, it cannot work well.
- When setting night guard mode, be sure that detector should be connected well.
- Sufficiently charge the battery of wireless handset before using it. Be careful that children should not throw battery. Be sure to close battery cover (When children throw or disassemble battery, it may cause serious accidents).
- Be careful that the polarity of the product matches to that of guardroom communication cable. When polarity is reversed, it may cause abnormal operations of the product or apartment system as a whole.

4-Line Related Products: KVM-930, 931, 960, IP-203APB, AM-10KP, KCV-344/354

- In wiring work, be careful that wirings should keep away from the wall-mounting pegs or other furniture at regular interval. Contact of wiring with wall-mounting pegs, etc. may cause short-circuit, electric shock and fire (it is applied to all products with wall-mounting pegs).
- Use the prescribed standard wirings. Non-standardized wirings may give adverse effects on operation of product (it is applied to both video phone and CCTV).

CCTV Camera

- Do not install at noisy places.
- Do not install at the place exposed to electromagnetic waves.
Excessive electromagnetic waves may cause continuous noise on screen and mechanical troubles.
- When installing camera outdoor, please put it in the outdoor case. Otherwise, when it rains, the camera may be broken or operate incorrectly.
- Install the product at well-ventilated places.
- Do not use the product for medical or military uses.
- Do not install the product at humid places. It may cause reduction of the product's durability as well as fire and electric shock.
- When lens is stained with alien substances, clean it with soft cloth to prevent the damages on it.
- Install the product out of reach of children.

Precautions for Operation

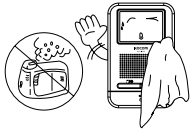

Keep away from humidifier and stove. High temperature and humidity can cause breakdown.



Do not drop monitor or door camera, and avoid strong impact.



Keep away from devices generating strong magnetic field (TV, Speaker, etc.) (Picture can be disturbed or blurred and breakdown can result)



When cleaning, never use wet hands, volatile benzene or paint thinner.

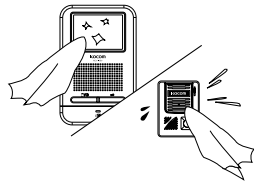

Keep picture clear by cleaning camera window frequently with soft cloths.

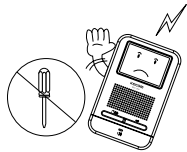

As this device consists of electronic precision components, and high voltage is generated internally, do not attempt to disassemble.

Installation Precautions

- Monitor and camera must be installed away from direct light and counter light.
- Camera must be installed at a place free from rain.
- Standard height of monitor must be 1,450mm~1,500mm from ground, centered around brown tube.
- Camera should be installed on the wall in which cement is completely dry.
- If installed during winter season at temperature below -5° , condensation might be generated inside monitor and camera due to temperature difference between indoors and outdoors. To prevent breakdown due to such condensation, connection should be made in 2 hours or more after installation.
- Do not install monitor and camera in locations subject to direct heating as harmful gases may subsequently be emitted in significant amounts.

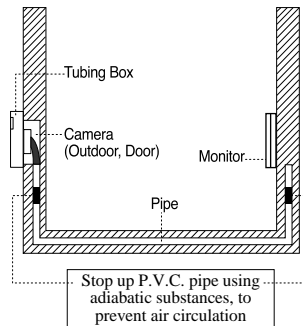

※ Stopping up pipe as above minimizes temperature difference between indoors and outdoors, and also eliminates moisture and condensation on door camera window.

Component's Name

■ KCV-350 / KCV-D350

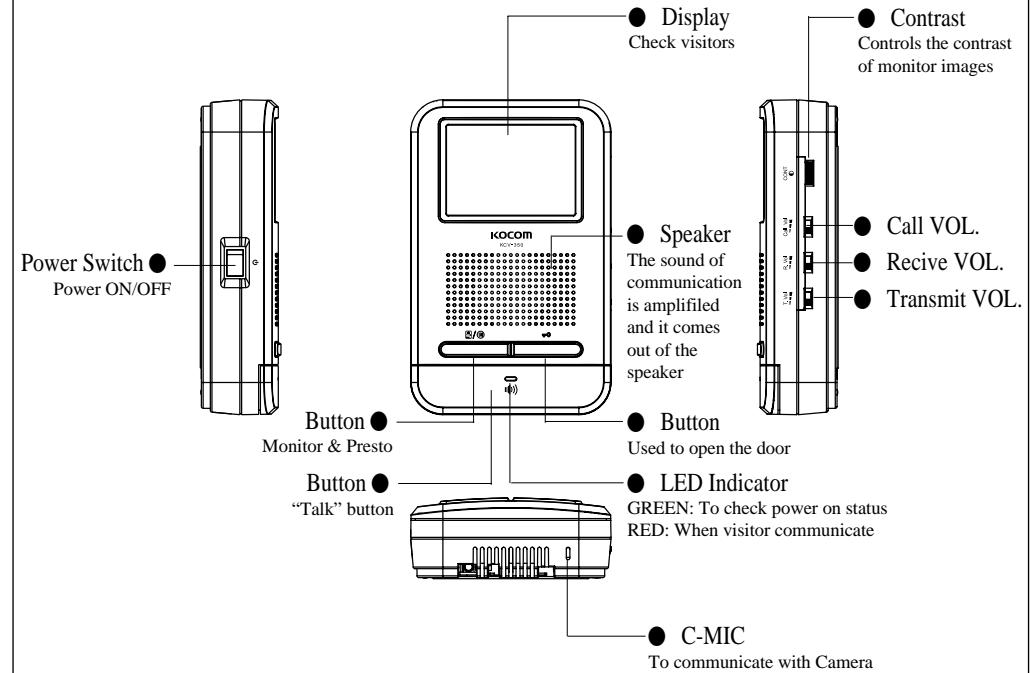

■ KC-D32 Metal Pinhole Camera

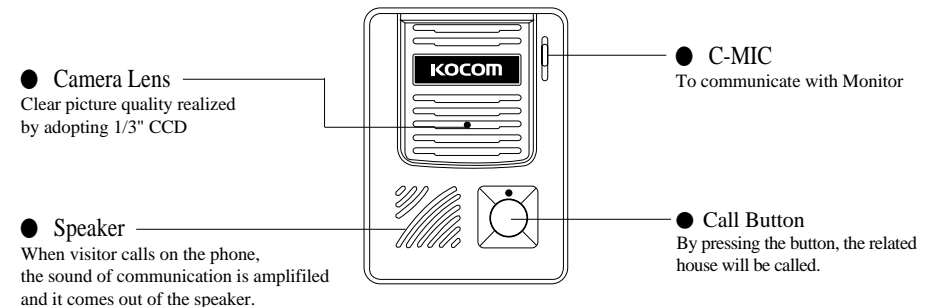

Monitor Installation

Basic Installation method of Monitor

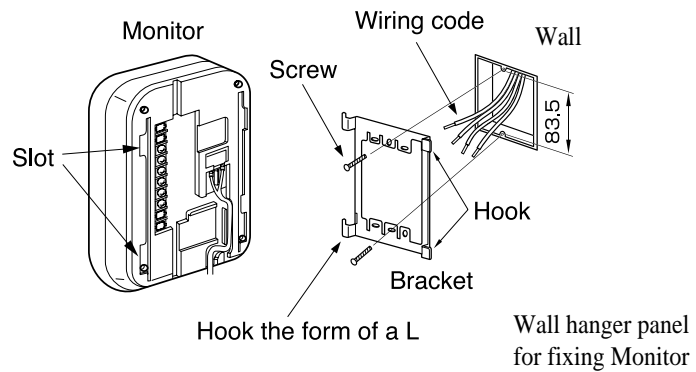

■ Cautions for Safety

Install the camera to be not exposed to direct rays of the sun.

If there is backlight, sometimes it's hard to identify visitors, because the visitor's face become dark.

So, please refer to below illustrations for installation.

- Place whose background is exposed to sky.

- Place in which direct rays of the sun is reflected by white wall at the front.

- Place arrived direct ray of sun or strong ray.

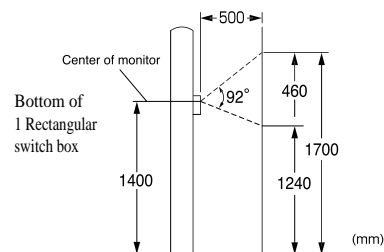
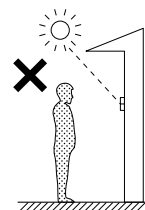
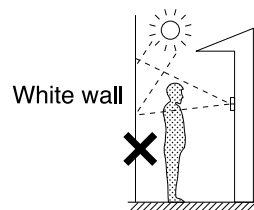
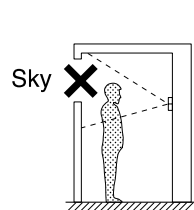

Door camera Installation

■ KC-D32 Surface-mounting Door Camera Installation

Straight Ahead Installation

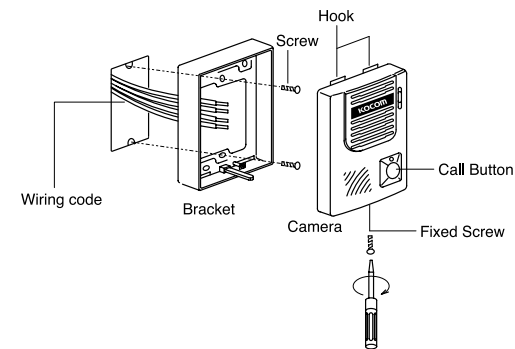

After attach the body supporter with 2 screws, put the Door Camera into the grooves of body supporter, and then fix it with 2 screws and stick the finishing materials.

■ Standard Height of Door Camera

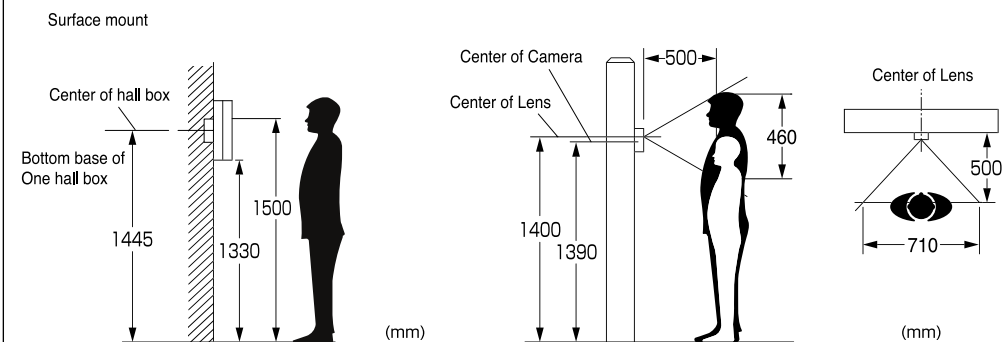

- Standard height of the door camera is 1,400mm ~ 1,450mm from the bottom of one camera to the floor.
- In case that the height of Door camera exceeds the range of min. 1,250mm~1,550mm, it is impossible to control the screen picture with only the lens angle, and therefore, be careful of the height of camera installation.

Component

● Monitor

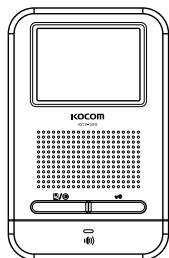

● Monitor Accessories

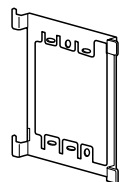

- Wall hanger panel
- ※ Wall hanger panel is packed in the Monitor

- Screws for fixing
4 x 30mm

● Camera



● Camera & Camera Accessories

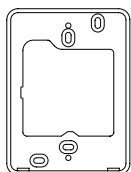

- Main body supporter



- Lench M2



- Screw for fixing camera
main body supporter
2.5 x 6mm



- Screws for fixing camera
4 x 20mm(GTS-1)

Product Specifications

※ Little video or voice noises may be occurred on rare occasion by side effect from external electromagnetic field relevant to 'video / audio carrier' or 'Harmonic frequency'.

■ KCV-350 / KCV-D350 Monitor

Power KCV-350 : AC 100V - 240V ~ 50/60Hz
KCV-D350 : DC 18V ±3V

Power consumption standby: 1.2W, operating: 10W

Communication Method Handsfree (One-way)

Available Image Displaying Time About 60 seconds from call to front door camera

Available Communication Time About 3 minutes under communication state with front door, lobby, and guardroom

The Number of Wirings 4-Line Polar Wiring

Display 3.5" Color TFT LCD

Dimensions 112(W) X 176(H) X 43(D)mm

Communication Coverage Front Door Camera: 50m when using 0.65mm

Guaranteed Operating Temperature Guaranteed Temperature for Monitor: 0° C ~40° C

Product Specifications

■ KC-D32 Front Door Camera

Power DC 12V ±1V (Supplies power for monitor)

Power consumption Max 3W

Image Device 1/3 inch CCD

Lens F:2.0, f=3.0mm

Installation Embedment Type

Dimensions 95(W) X127 (H) X 46(D)mm

Minimum Illumination 0 ~ 20 Lux (LED ON)

Scanning Frequency Horizontal 15,625 KHz or 15,732 / Vertical 50Hz or 60Hz

Guaranteed Operating Temperature -10° C ~ 50° C

Exterior Wiring Diagram

■ KCV-350

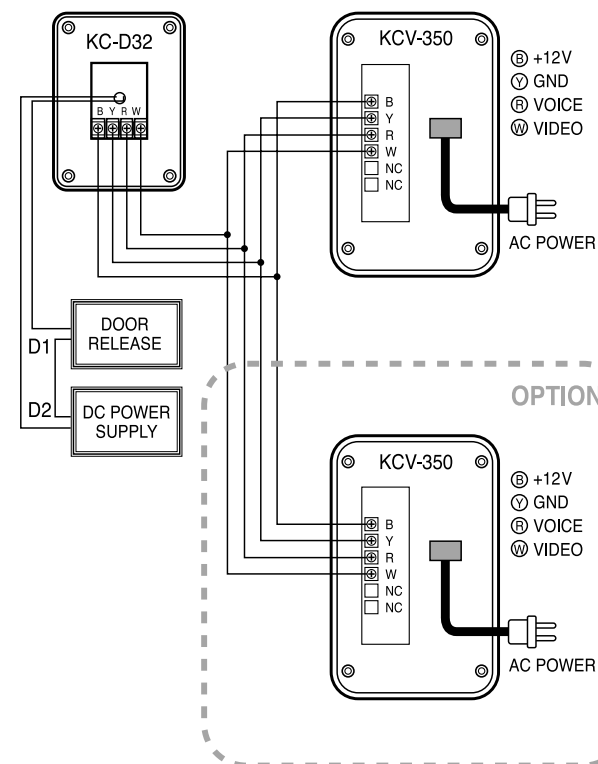

Exterior Wiring Diagram

■ KCV-D350

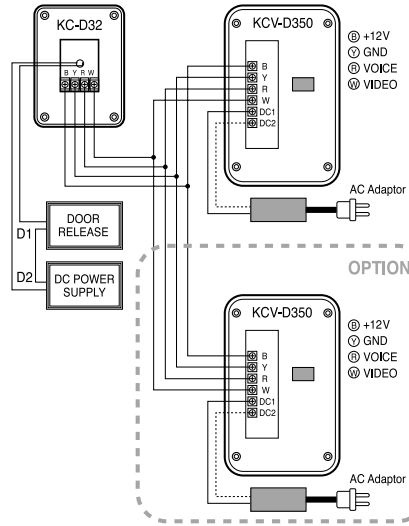

Instructions for Operation

■ Calling from camera



- Press the "Call" button (when the "Call" button is pressed, call signal sounds).



- "Ding-dong" The image come up on the screen and Call signal sounds.



- If "Talk" button is pressed, communication will become available.

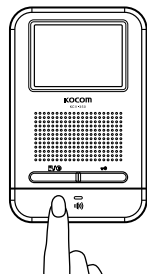

- If "Talk" button is pressed again, communication will be over.

■ Monitoring & Presto function (📺/🔊)

- ※ For identifying image of camera.

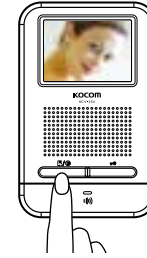

- If you press the button, image will be emerged on screen. If you press the button once again, the screen will be turned off. (At this time, you can catch sound only from camera. If you press the "Monitor & Presto" button, communication will become available).

- ※ Presto function (This function is available during only communication).

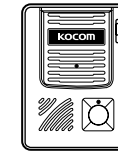
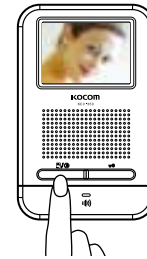

- Only during communication, one-way communication is available while the "Monitor & Presto" button was being pressed for over 2 seconds. (You cannot hear from the camera, but the voice from monitor is generated to the outdoors).

■ Door release function (🔑)



- This function is available during only communication. Only while the button is being pressed, door release function is on.