

Warranty



To receive after-Sale service, have the following ready when you contact our branches

1. Name of the product
2. Model number of the product
3. The area of problem
4. Phone number and address at which you can be contacted.

Warranty Card

PRODUCT	
MODEL	
DATE PURCHASED	
WARRANTY PERIOD	
AGENCY ADDRESS	

■ KOCOM Warranties the original purchaser of this product as follows.

- 1) This product is produced under strict quality control and inspection procedures.
- 2) If this product breaks down during proper use as a result of product defect, KOCOM will repair it within one year from date of purchase free of charge.
- 3) The following cases will be subject to charge, even during warranty period:
 - a. Breakdown during transport, or through careless treatment, by consumer.
 - b. Breakdown cause by unauthorized repair, or system modification.
 - c. Breakdown caused by natural disaster or power disorder.

This manual is based on the date as shown in the right and specifications are subject to change without notice for quality improvement.

04. 07

KOCOM®

DOORPHONE for Apartment Unit

KDP-104B. 108B. 112B Manual for Operation and Installation

This is bulletin is for the KDP-601A

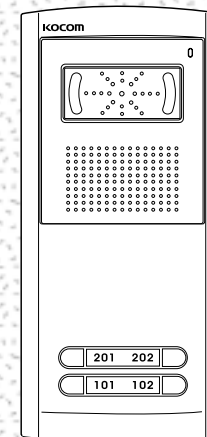

KDP-104B

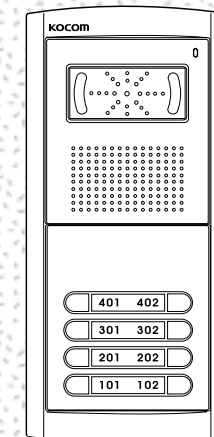

KDP-108B

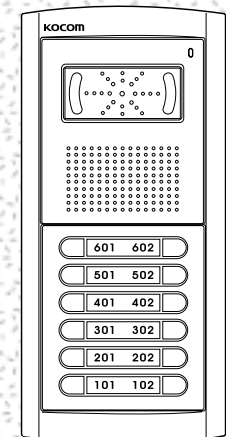

KDP-112B

KOCOM CO.,LTD.

This is bulletin is for the KDP-601A

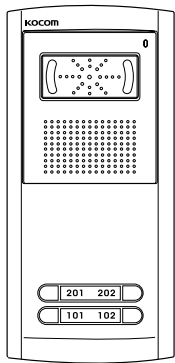

■ KDP-104B

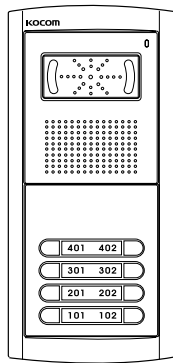

■ KDP-108B

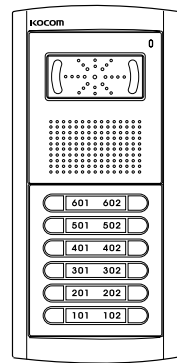

■ KDP-112B

This manual is based on the date as shown in the right and specifications are subject to change without notice for quality improvement.

KOCOM CO.,LTD.

Component's Name

Model: KDP-112B as standard

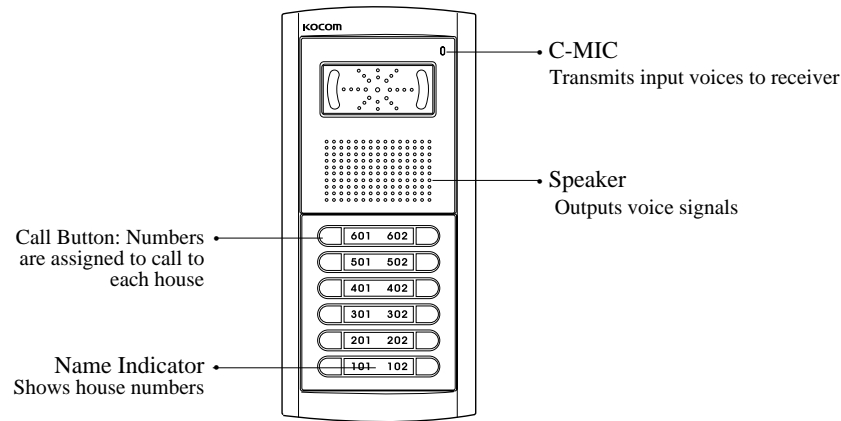

※ KDP-112B has same functions except for the number of houses to be called.

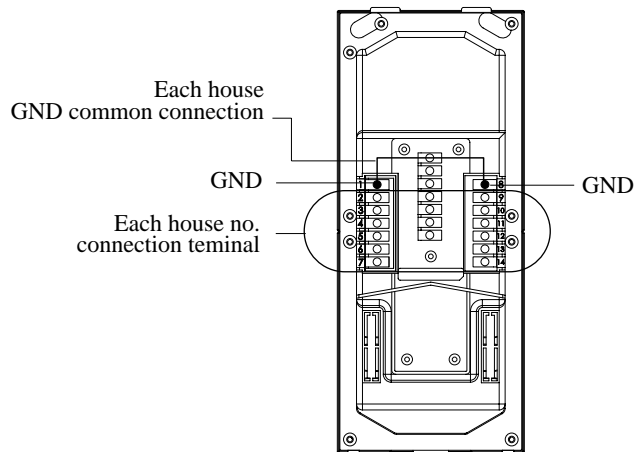

■ Wiring Specifications

- Main Wiring: 2-line polar wiring, over IV 0.8mm applicable

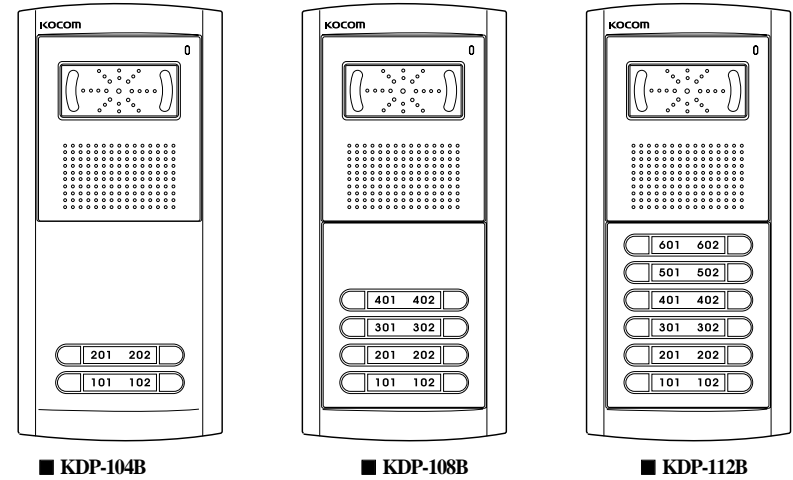

Product Specifications

	KDP-104B/108B/112B
Input Power	Power from KDP-601A
Exterior Material and Color	METAL (Zn , Al) / SILVER
Dimensions	255(W) X 120(H) X 20(D) mm
Guaranteed Operating Temperature	-10° C ~50° C

Operational Descriptions

- Corrected operating instructions:
 - These instruction are for door phone for multiple family residences.
When the handset is picked up , the LED will turn on and then off.
 - To call another residence in the building, key in the residence number on your door phone number pad.
The unique sound “Ding-dong Ding-dong” will sound at the residence you called.
When the residen answers the call, you begin talking.

External Wiring Diagram

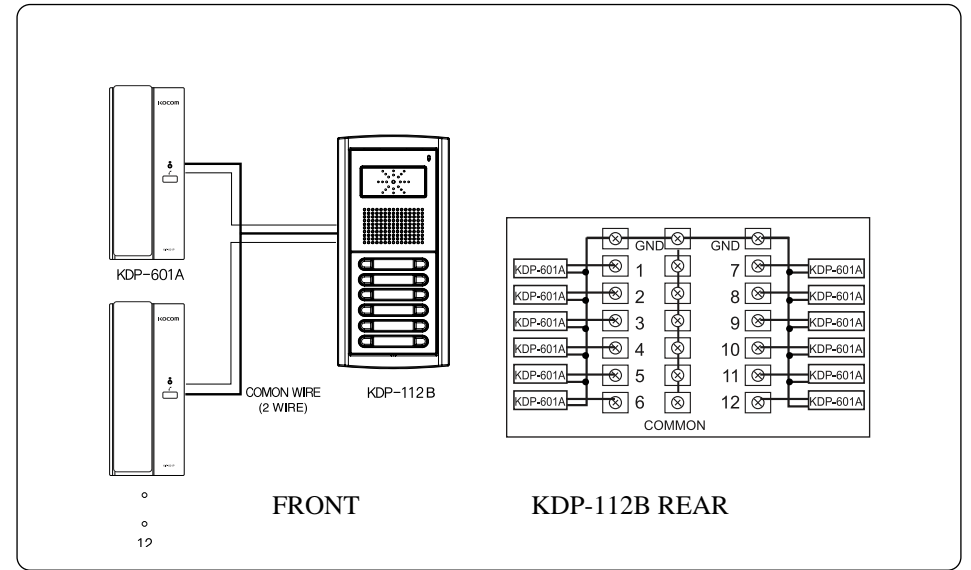
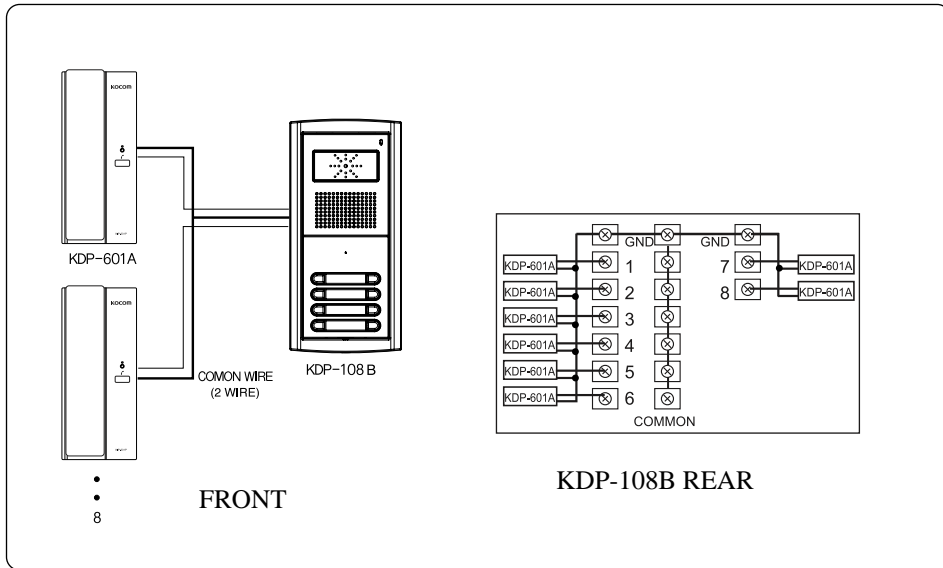
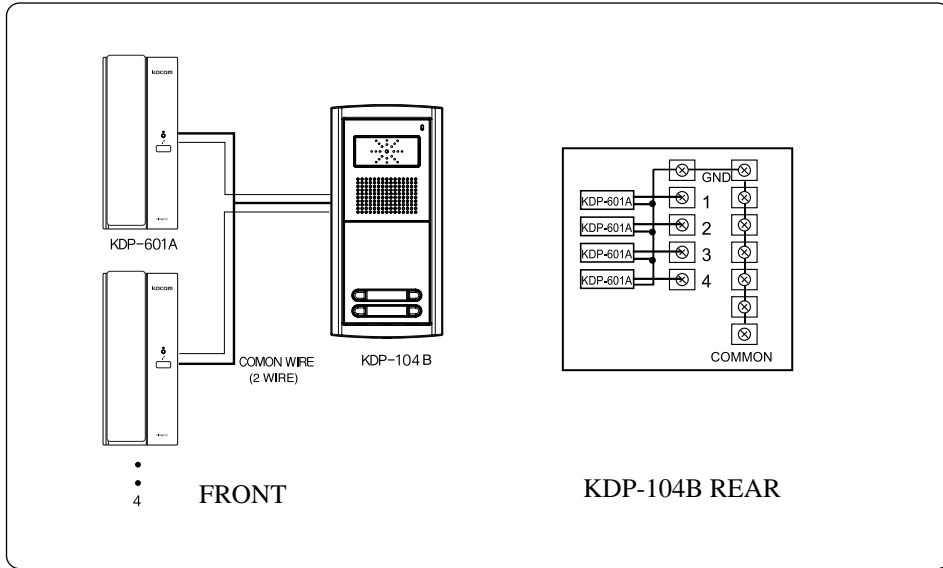

Assembly Chart

