

Column spacers



901 housing with 200mm sun shield



Accessories

600DER infra red mounting plate

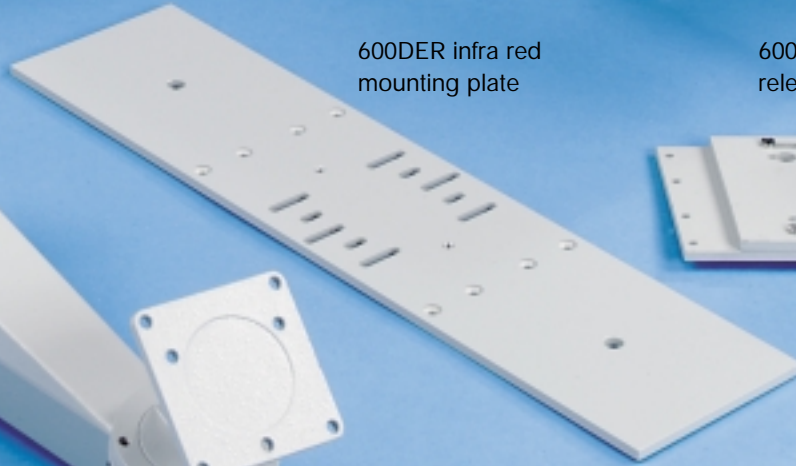

600/RuP quick release plate



Bracket with fixed pan & tilt adjuster

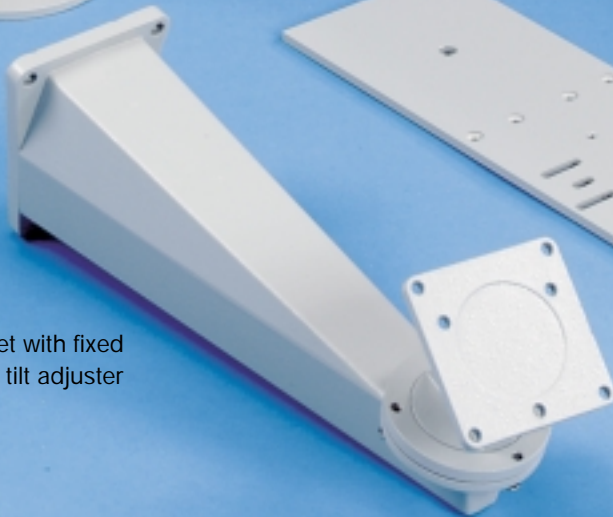

Sombrero bracket
Stetson bracket

With fixed pan & tilt adjuster
Without pan & tilt adjuster

Rigid, yet light and stylish

Dual process heat treated gravity die cast aluminium construction

Fez column spacers

Available in any length

Strong, lightweight

High tensile extruded aluminium construction



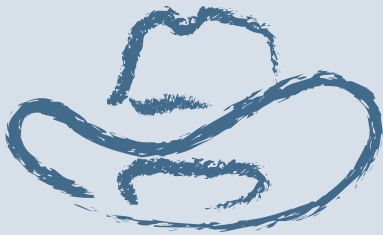

Stetson bracket
without pan & tilt adjuster

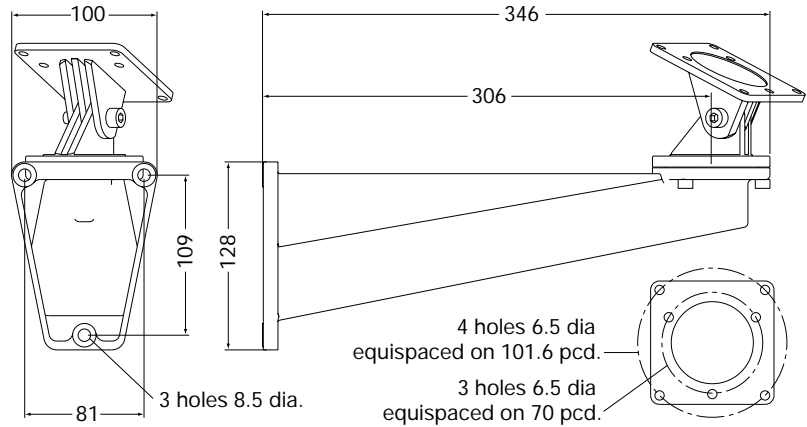

Dimensions (mm nominal)

Wall to mounting centre	305 102
Overall length	346 102
Overall height	122
Overall width	100
Weight (kg)	1 approx.
Fixing Centres	3 Holes, 6.35 dia. equispaced on a 70mm PCD
Colour	Goose Grey, Textured, Semi Gloss (BS4800 00 A05)

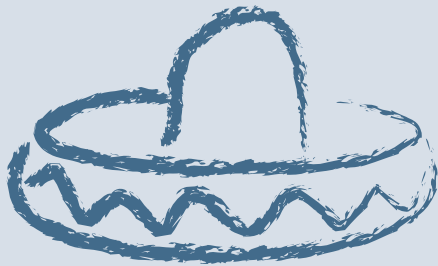

Sombrero bracket
with fixed pan & tilt adjuster

Dimensions (mm nominal)

Wall to mounting centre	306
Overall length	346
Overall height	182
Overall width	100
Weight (kg)	1.2 Approx
Fixing Centres	3 Holes, 6.35 dia. equispaced on a 70mm PCD Plus 4 Holes, 6.35 dia. equispaced on a 101.6mm (4") PCD
Angles (°)	Pan 360 Tilt -80 to +25
Colour	Goose Grey, Textured, Semi Gloss (BS4800 00 A05)



Fez column spacers

Column spacers are manufactured with 4 X 6.5mm holes on a 101.6mm pcd (4"), or with 80mm dia end plates with 3 X 6.5mm holes on a 70mm pcd. Other plates and configurations can be made to order

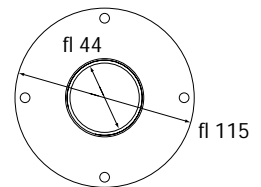

Standard PCD's	4 Holes, 6.35mm on 101.6 (4") PCD
Standard Lengths (mm)	150, 225, 300
Non Standard Lengths	PCD's and combinations available on request
Colour	Goose Grey, Textured, Semi Gloss (BS4800 00 A05)

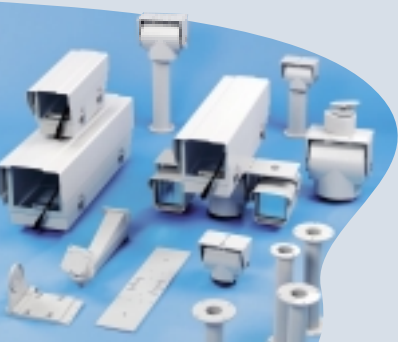
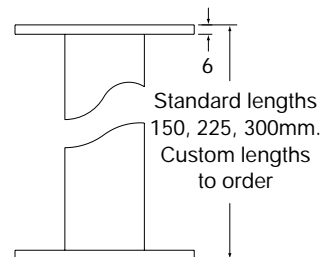

Metham Aviation Design Limited
Station Approach, Four Marks, Alton
Hampshire GU34 5HN, UK

Tel: +44 (0)1420 565618. Fax: +44 (0)1420 565628
Email: info@madcctv.com Web: www.madcctv.com

